

lapalma

lem

design shin & tomoko azumi  
2000



"Un forma continua che aleggia nell'aria".  
Lo sgabello crea una leggerezza visiva e  
l'illusione di essere libero dalla forza di  
gravità.

"Lo spazio nell'arredo, l'arredo nello  
spazio". L'ampio spazio vuoto circoscritto  
dalla struttura continua crea una relazio-  
ne armonica tra l'arredo e l'ambiente cir-  
costante.

Shin & Tomoko Azumi

*"A loop which is floating in the air". This  
stool creates a visual lightness and an il-  
lusion as if it was free from gravity.*

*"Space within furniture, furniture within  
space". The large void space within the  
loop structure creates a gentle relation-  
ship between the furniture and the sur-  
rounded environment.*

Shin & Tomoko Azumi



## h 55 / 67

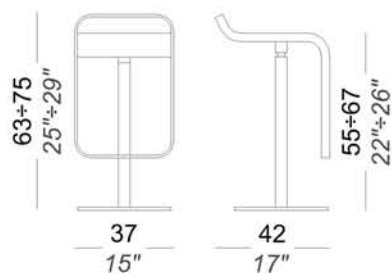

Sgabello girevole ad altezza variabile con molla a gas. Telaio in metallo cromo satinato e base in metallo rivestito in acciaio inox. Sedile in varie finiture.

*Stool with swivel seat and adjustable height with gas spring. Metal frame mat chromed and base in zinc-plated metal covered by a stainless steel sheet. Seat in several finishes.*



test: DIN 68 877/81

## h 66 / 79

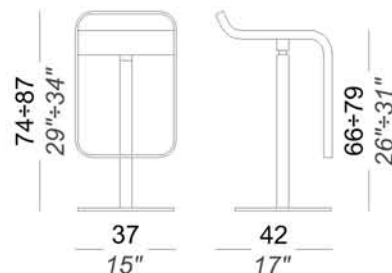

Sgabello girevole ad altezza variabile con molla a gas. Telaio in metallo cromo satinato e base in metallo rivestito in acciaio inox. Sedile in varie finiture.

*Stool with swivel seat and adjustable height with gas spring. Metal frame mat chromed and base in zinc-plated metal covered by a stainless steel sheet. Seat in several finishes.*



test: DIN 68 877/81

## h 80

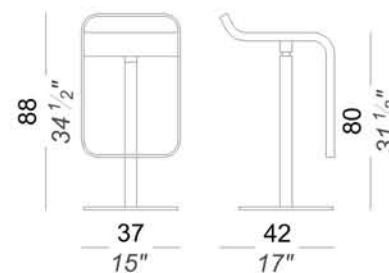

Sgabello girevole ad altezza fissa. Telaio in metallo cromo satinato e base in metallo rivestito in acciaio inox. Sedile in varie finiture.

*Stool with swivel seat with fix height. Metal frame mat chromed and base in zinc-plated metal covered by a stainless steel sheet. Seat in several finishes.*

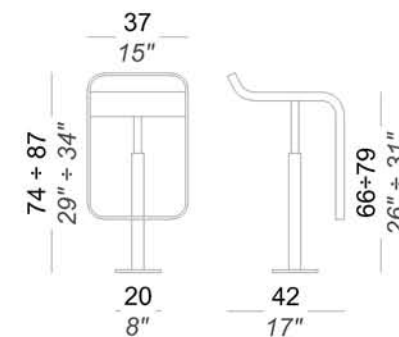

test: DIN 68 877/81

autoallineante  
self-returning

Sgabello girevole ad altezza variabile con molla a gas, con dispositivo di ritorno automatico e autoallineamento del sedile. Telaio in metallo cromo satinato. Base per fissaggio a pavimento in metallo rivestito in acciaio inox. Sedile in varie finiture.

*Stool with swivel and adjustable height with gas spring and self returning mechanism. Metal frame mat chromed and floor fixing base in zinc-plated metal covered by a stainless steel sheet. Seat in several finishes.*



test: DIN 68 877/81



Disponibile con dispositivo di ritorno automatico e autoallineante del sedile.

*Available with self-returning mechanism to original height and position.*



Leva in acciaio inox e blocchetto in pressofusione di alluminio.

*Lever in stainless steel and pivot in die-cast aluminium*



Base rivestita in acciaio inox Aisi 304 con feltri in lana.

*Aisi 304 stainless steel base with wool felt*

finiture / finishes



faggio sbiancato  
*bleached beech*



rovere sbiancato  
*bleached oak*



rovere noce scuro  
*oak dark walnut*



nero poro aperto  
*black open pore*



laccato bianco  
*white lacquered*



laccato nero  
*black lacquered*



"millerighe" bianco  
*white "millerighe"*



"millerighe" alluminio  
*aluminium "millerighe"*



tessuto tecnico nero  
*technical black fabric*

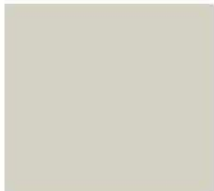

acciaio inox  
*stainless steel*



Corian white glacier  
*Corian white glacier*



cuoio bianco  
*white leather*

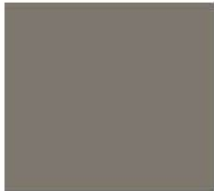

cuoio grigio  
*grey leather*



cuoio fango  
*mud leather*



cuoio rosso  
*red leather*



cuoio tabacco  
*tobacco leather*



cuoio marrone  
*dark brown leather*



cuoio nero  
*black leather*



tessuto Highfield 651  
*Highfield fabric 651*



tessuto Highfield 951  
*Highfield fabric 951*



tessuto Highfield 191  
*Highfield tessuto 191*

finiture / finishes

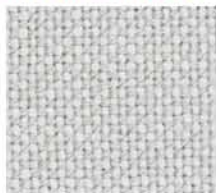

tessuto Hallingdal 103  
Hallingdal fabric 103



tessuto Hallingdal 224  
Hallingdal fabric 224



tessuto Hallingdal 674  
Hallingdal fabric 674



tessuto Hallingdal 960  
Hallingdal fabric 960

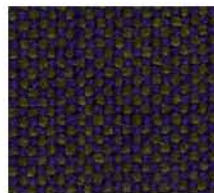

tessuto Hallingdal 968  
Hallingdal fabric 968



tessuto Hallingdal 702  
Hallingdal fabric 702

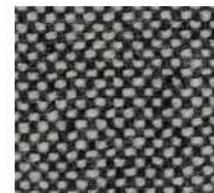

tessuto Hallingdal 126  
Hallingdal fabric 126

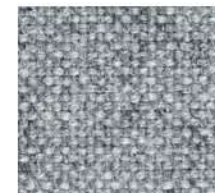

tessuto Hallingdal 130  
Hallingdal fabric 130



tessuto Hallingdal 153  
Hallingdal fabric 153



acciaio inox  
stainless steel



Cromo satinato  
mat chrome

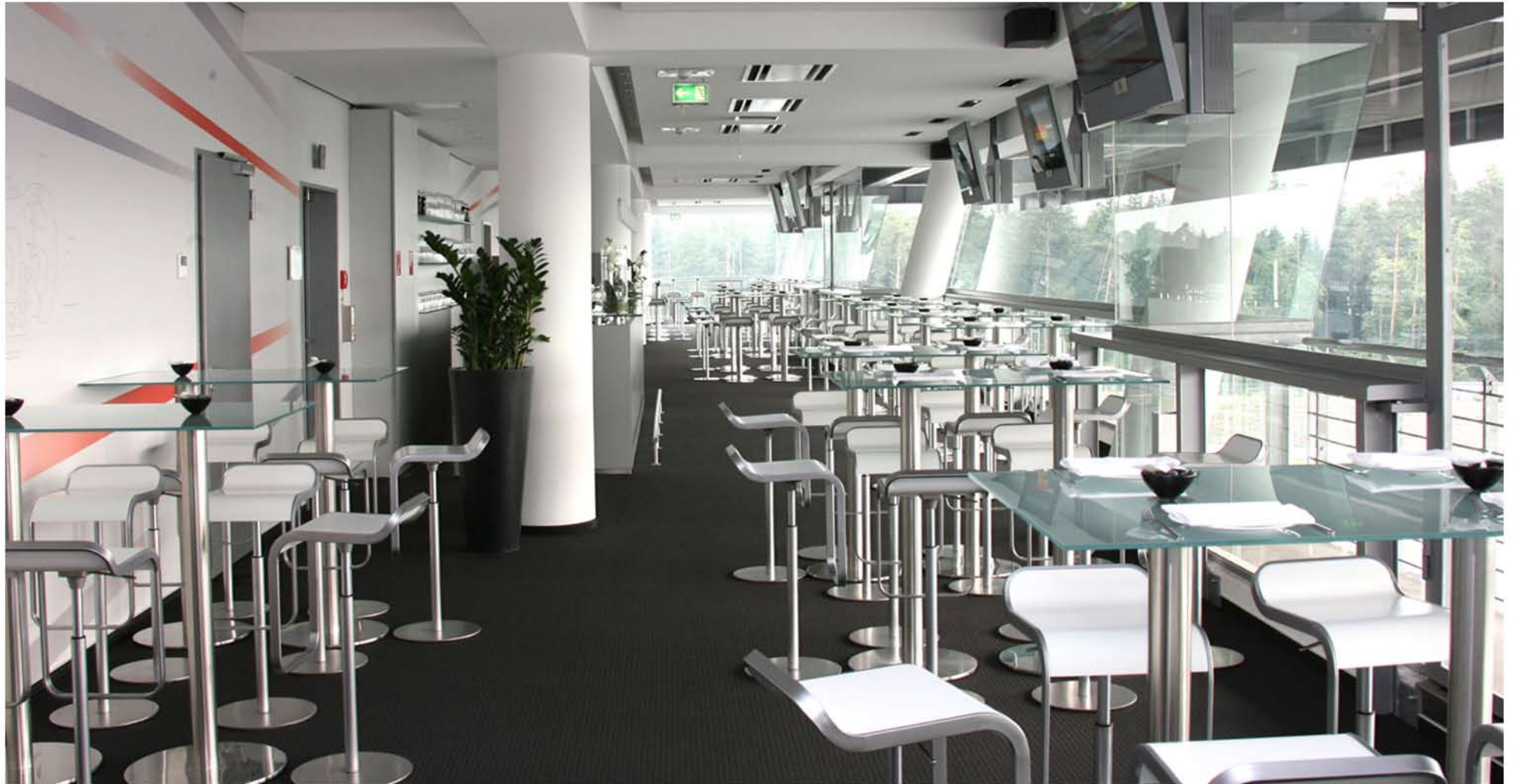



Premi / Awards



**Restaurant & Bar  
Design Awards**



**i**nterior innovation award cologne



## ISTRUZIONI D'USO E MANUTENZIONE

Pulire tutte le parti in legno, cuoio, tessuto e metallo con un panno umido, o con detergente liquido neutro diluito.

Non usare prodotti a base alcolica, candeggina, solvente o prodotti abrasivi.

Liquidi versati sul prodotto devono essere asciugati subito.

Per sollevare e spostare il prodotto non afferrare solo il sedile, bensì afferrare saldamente la struttura.

Il prodotto non deve essere sottoposto a carichi decentrati, è stato progettato per essere utilizzato in condizioni normali di appoggio (su quattro gambe o sulla base). L'azienda si solleva da ogni responsabilità per eventuali danni provocati su pavimenti delicati o teneri.

Evitare l'uso improprio del prodotto: non salire sul prodotto con i piedi, nè sul poggiatesta o sui braccioli. In particolar modo evitare oscillazioni che potrebbero pregiudicare il funzionamento e la sicurezza dell'utente.

Il legno ed il cuoio sono, per loro natura, facilmente danneggiabili, alcune piccole impurità e imperfezioni rientrano negli standard di qualità accettati.

Non esporre alle intemperie, agli agenti atmosferici né a fonti di calore superiori a 40°C. I prodotti destinati all'uso esterno subiscono comunque nel tempo l'azione degli agenti atmosferici. Eventuali alterazioni superficiali possono verificarsi a specifiche condizioni di esposizione di temperatura, umidità e salinità. Una corretta e frequente manutenzione e pulizia aumentano la durabilità del prodotto.

Il prodotto se è esposto alla luce del sole può essere soggetto a variazioni di colore.

Interventi di manutenzione devono essere eseguiti da personale esperto.

Smaltire l'imballo solo a completamento dell'assemblaggio, onde evitare lo smarrimento di eventuale ferramenta e componenti.

Una volta dimesso, il prodotto od i suoi componenti vanno conferiti ai sistemi pubblici di smaltimento secondo quanto previsto dalla legislazione in vigore.

## USE AND MAINTENANCE INSTRUCTIONS

*Clean all parts in wood, leather, fabric and metal with a damp cloth or a diluted neutral cleaner.*

*Do not use cleaners with alcohol, bleach, solvent or abrasive products.*

*Any liquid spilt on the product must be wiped up immediately.*

*When lifting or moving the product, hold it on the structure and not under the seat.*

*The product should not be subjected to unbalanced weights, as it is designed for a proper rest on the foothold (on four legs or on the base). Our company relieves from any responsibility in case of damage caused to fragile floors.*

*Avoid any improper use of the product: do not step on the product, on the footrest or on the armrests. Avoid any movements that could compromise the proper functionality of the product or the safety of the users.*

*Wood and leather, being natural materials, could be easily damaged. Small impurities or imperfections are within quality standard range.*

*Do not expose the product to weather conditions or atmospheric agents, nor to heat sources over 40°C. Also products for outdoor use could be afflicted by atmospheric agents. The product could undergo possible exterior changes due to particular exposure to heat, humidity and saltiness. An appropriate and frequent maintenance and cleaning of the product enhances its durability.*

*The product could change colour and shade, if exposed to direct sunlight.*

*Maintenance has to be carried out by experienced staff.*

*Dispose of the package only after assembling the product, in order to avoid the loss of ironmongery and components.*

*Once the product has been dismantled, the product itself or its components must be given to the public garbage disposal system, according to the legislation in force.*